

Varenummer: 2031120M24100B2T  
 Beskrivelse: E+G Justerfod  
 GN 31-120-M24-100-B2-T  
 Note: T Uden møtrik, spændeflade i bunden

## Mål

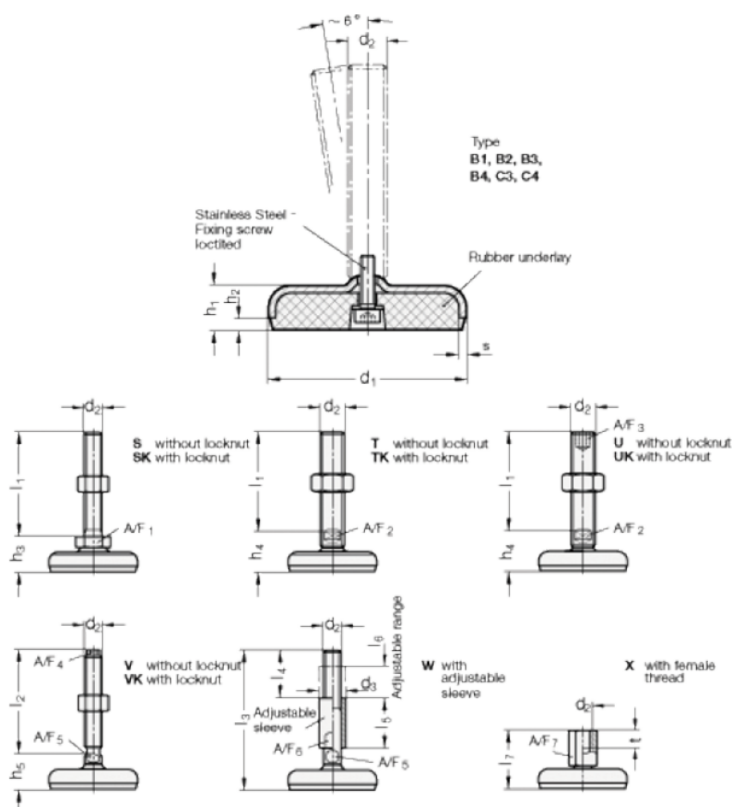

A/F2	= 19
d1	= 120
d2	= 24
h1	= 22
h2	= 6
h4 +4.0/0	= 42
l1	= 100
s	= 4